

Part numbers contained in this manual were in effect at the time the manual was approved for printing and are subject to change without notice or liability, Fabco Automotive Corporation reserves the right to change parts at any time.

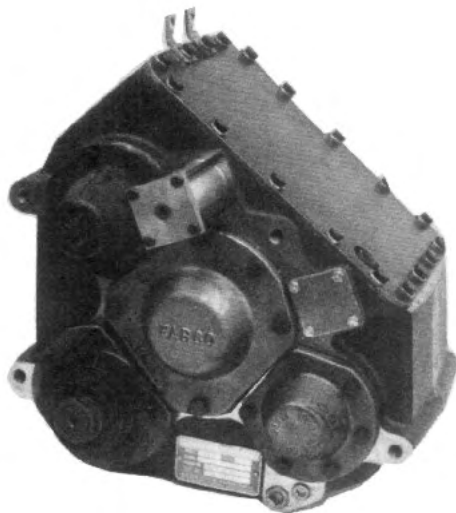

# TC-38

## Transfer Case

SERVICE MANUAL

Before ordering parts for a Fabco transfer case, please refer to the Fabco nameplate located on the transfer case housing. Specify model number, serial number, part number, or other information that is on the nameplate when ordering parts.

### I. LUBRICATION

- A. Initial oil change should be made after no more than 5,000 miles have been driven.
- B. Regular oil changes should be made at an interval selected by the user. An interval between every 10,000 to 15,000 miles should be satisfactory unless operating conditions indicate a lesser interval is necessary.
- C. The location of the drain, fill and level plugs is indicated on the next page.
- D. Proper lubricant level is to the bottom of the oil level hole.
- E. Check lubricant level at regular intervals; watch for indications of possible oil loss.
- F. Approximate oil capacity is 7 quarts.

## Recommended Lubricants

### On Highway Vehicles

Type	Grade	Temperature
MIL-L-2104B Heavy-Duty Engine Oil	SAE 50 SAE 30	Above + 10°F. Below + 10°F.
Mineral Gear Oil	SAE 90 SAE 80	Above + 10°F. Below + 10°F.
MIL-L-2105B E.P. Oil, except sulfur-chlorine-lead type.	SAE 90 SAE 80	Above + 10°F. Below + 10°F.

**Heavy-duty engine oil.** Make sure to specify heavy-duty type meeting MIL-L-2104B specifications.

**Mineral gear oil** inhibited against corrosion, oxidation and foam.

**Extreme pressure oils** under some conditions might form carbon deposits on gears, shafts and bearings which will result in transfer case malfunctions and premature failure. It is suggested that if these conditions exist, and E.P. oil is being used, a change should be made to mineral gear oil or heavy-duty engine oil as recommended.

### Off Highway & Mining Equipment

Type	Grade	Temperature
MIL-L-2104B Heavy-Duty Engine Oil	SAE 50 SAE 30	Above + 10°F. Below + 10°F.

#### Special Recommendation

For extreme cold weather where temperature is consistently below 0°F.

MIL-L-2104B Heavy-Duty Engine Oil	SAE 20W	Below + 0°F.
--------------------------------------	---------	--------------

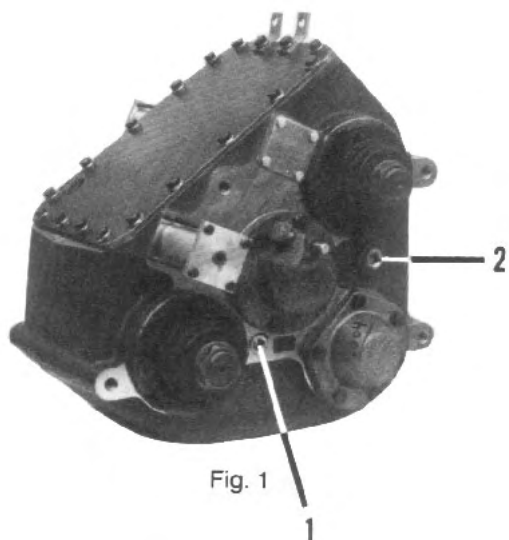

1. Oil Level Plug
2. Oil Fill Plug
3. Oil Drain Plug

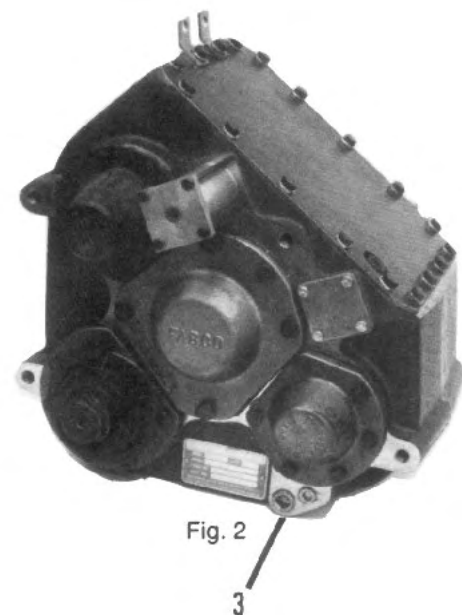

## II. DISASSEMBLY

### A. Preliminary Steps

1. After removing the transfer case from the vehicle, thoroughly clean the exterior.
2. Remove the drain plug and drain the unit. Remove the cover.
3. Shift Components Removal.
  - a. Remove the indicator light switch, spacer washers and, with a magnet, the plunger pin.
  - b. Cut lockwires from the fork retaining set screws and remove the screws.
  - c. Remove the shift cylinder caps and tubes. Remove the piston and shift shaft assemblies.

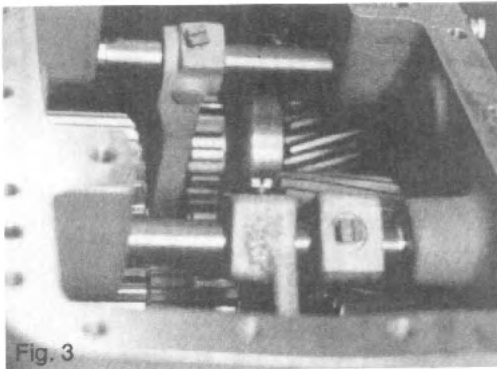

As the shift forks are removed, tag each with location and mark to indicate position and orientation thereby simplifying installation at assembly.

4. Remove the nuts and take off all yokes or flanges. The shafts can be prevented from rotating by engaging all three clutches.
5. Remove all seal carriers and bearing caps except the rear intermediate cap and, if so equipped, the PTO assembly.
6. Loosen all bearing locknuts.

### B. Input Shaft Removal

1. Remove the spacer from the front of the shaft. Pry the shaft forward, remove the bearing cup.
2. Remove the bearing locknut from the shaft.
3. Engage the clutch gear into the drive gear, restrain the clutch gear (not the drive gear) while pushing the shaft out the front of the case. Catch the bearing cones and spacers as they come off the shaft.
4. Do not remove the split ring from the shaft unless it is being replaced.

### C. Intermediate Shaft Removal

1. Remove the front nut from the shaft.
2. Remove the rear bearing cap.
3. Engage the clutch gear into the underdrive gear. Block between the clutch gear and the rear of the case housing. Push the shaft and direct drive gear out the back of the case. Catch the bearings and spacers as they come off the shaft.

### D. Rear Output Shaft Removal

1. Push the shaft out the front of the case and out of the gear, catching the bearings and spacers.

### E. Front Output Shaft Removal

Follow procedure outlined under "B" (input shaft removal).

### F. Remove the bearing cups from their gears only if replacing them.

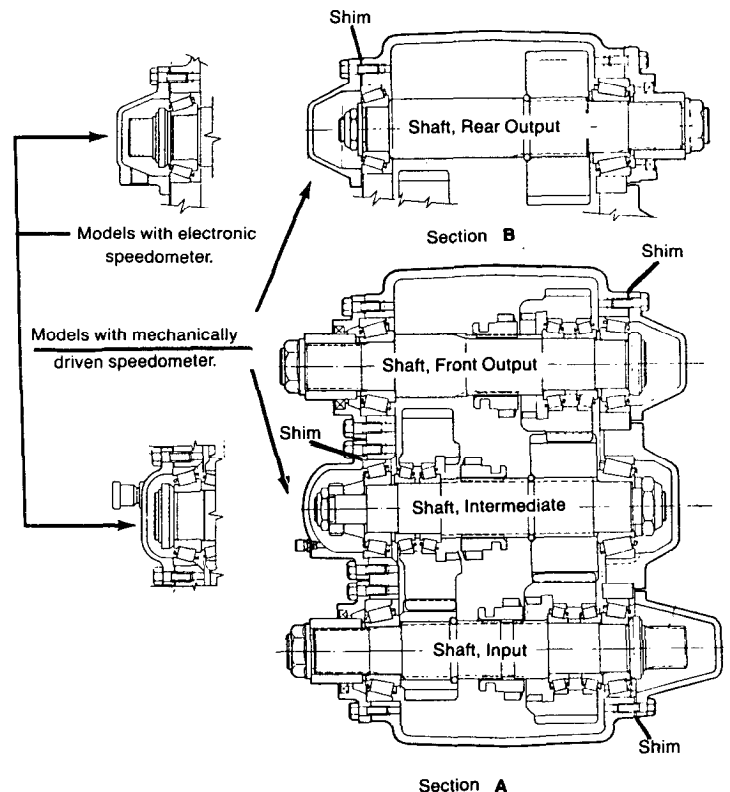

Fig. 4

### III. TRANSFER CASE ASSEMBLY

#### A. General Precautions

1. Read these instructions completely before starting reassembly. Refer to the appropriate exploded view. Assemble, adjust and check in the order shown.
2. Parts must be clean. Gasket surfaces must be free of old gasket material.

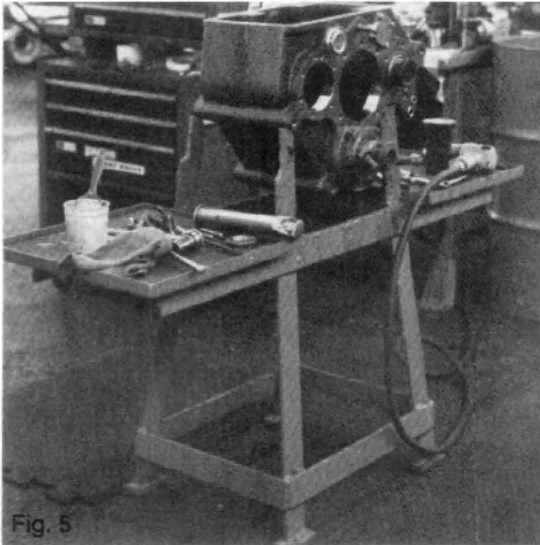

Fig. 5

3. Select a work area that will maintain the cleanliness of the parts and the assembly. Mount the case housing with the cover on top. The cover side, the front and rear of the case should be accessible. The housing must be restrained. A sturdy work bench or special stand should be used. The components of this transmission are heavy and positioning and installing them will be easier if the case is supported in the position indicated.
4. Lubricate housing bores, shaft spline and bearing mounting surfaces, sealing lips on oil seals with Lubriplate or equal. This is necessary to reduce the chances of galling or scoring and to provide initial lubrication for the oil seals.
5. Installation of gaskets, bearing carriers, seal carriers and caps will be simplified if two temporary guide studs are utilized.
6. Universal joint yokes or companion flanges should be coated with Lubriplate on the seal operating area before installation. They should be tightened into place with the locknuts tightened to the proper torque before the cover is installed on the case and before the shim thickness is determined. Universal joint yoke or companion flange retaining nuts can be tightened or loosened most easily when all components except shift forks are in place. At that time it is possible to engage both the direct drive and the underdrive clutch gears and effectively lock all the shafts against rotation.

7. Seals supplied by Fabco are coated on the outside and should not be coated with Permatex before installation in their carriers. They should be coated on the sealing lip with Lubriplate.
8. Use Permatex Form-A-Gasket #2 or equal pliable setting sealant on bolt threads. If bolt threads are not sealed they will leak oil.
9. All bolts and nuts should be tightened to torque indicated on torque chart.
10. Allow heated components to cool to room temperature before making bearing adjustments.

#### B. Clutch Gear and Bearing Assemblies

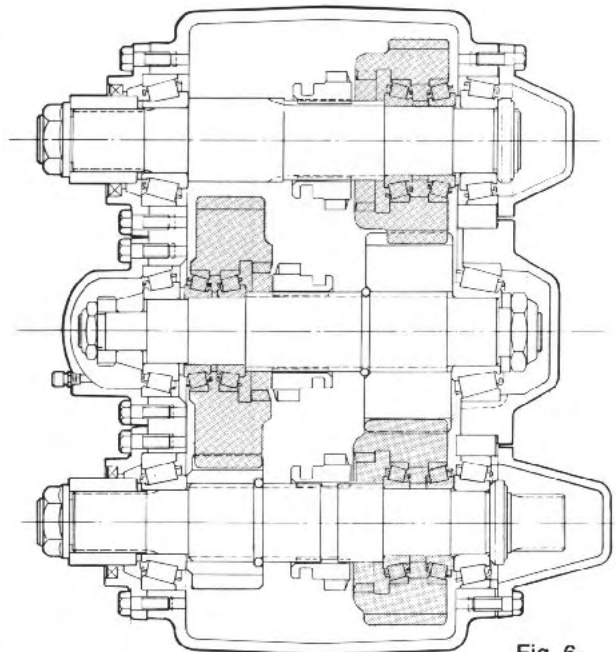
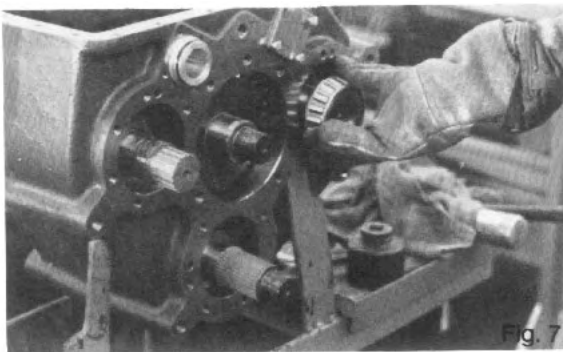

Fig. 6

1. A light coat of Lubriplate should be applied to the bore of the gear before pressing the cups into place.
2. Check the end play as follows:
  - a. Match the gear with the shaft. Slip a clutch onto the shaft (to aid in disassembling). Slide a bearing cone onto the shaft followed by a spacer. Put the gear into place and then the second bearing cone. Clamp the bearing-spacer-bearing assembly in place utilizing a temporary spacer tube between the second bearing cone and the nut.
  - b. The axial end play between the gear and the shaft should now be between .003" and .008". If not, change the spacer between bearing cones.
  - c. Remove the gear, bearing cones, spacers and the clutch from each shaft. Keep the set of parts thus selected in an area that will insure their installation in the case as a matched set.

## C. Front Output Shaft Assembly

1. Heat front bearing cone to approximately 250 degrees F. Use heat resistant gloves to handle the bearing. Install bearing on the splined end of the shaft.
2. Insert the shaft into the case passing it through the clutch which is lowered into place through the cover opening.
3. Slip one bearing cone onto the shaft along with the spacer.
4. Lower the gear, with bearing cups installed, into the case. Pull the shaft forward enough to allow the shaft end to be inserted into the gear. Slip the second bearing cone into place and slide the spacer washer into place.



5. Install the rear bearing cone that has been heated (as discussed in Step #1) onto the shaft. Loosely install the bearing locknut.
6. Insert the rear bearing cup in place and temporarily install the cap without any shims using two opposing bolts.
7. Install the front bearing cup in the case and the gasket. Coat the seal — which has previously been installed in the seal carrier — with Lubriplate. Also coat the splines on the end of the shaft. Install the seal carrier on the front of the case. Install bolts with threads coated with Permatex.
8. Coat the universal joint end yoke from the vehicle with Lubriplate on both the spline bore and the sealing area. Install on the shaft and tighten the locknut, taking care not to damage seal lips.
9. Remove the rear cap and tighten the locknut.
10. Once again, temporarily install the cap. Do not install shims. Tighten the retaining bolt to approximately 25 lb. ft. torque. Measure the gap between the cap and the case housing. Add .005" to this dimension and then select a shim pack that is equal to this total within plus or minus .003". Install shims and cap.
11. Check the shaft end float between the shaft and the housing. End float should be between .003" and .008".

## D. Rear Output Shaft Installation

1. Install split retaining ring on shaft.
2. Press front bearing cone into place tight against shaft shoulder, install washer and locknut.
3. Coat the splined bore of the gear with Lubriplate.
4. Lower rear output gear into the case with flat face against the back wall of the case, the chamfered side toward the front of the case.
5. Coat the shaft splines with Lubriplate.
6. Insert the rear output shaft through the front of the case and align the shaft splines with the gear splines. Use a brass or aluminum rod to protect the threaded shaft end and tap the shaft into the gear until the retaining ring seats in the chamfer of the gear.

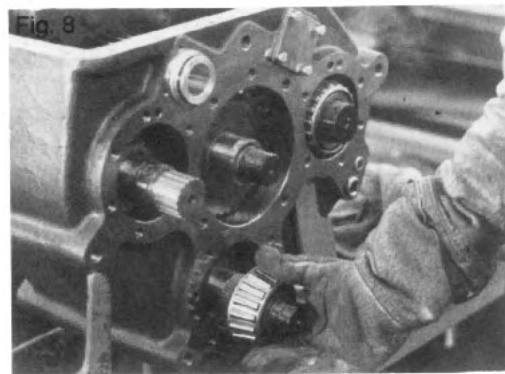

7. Install the spacer ring. Heat the rear bearing cone to approximately 250 degrees. Use heat resistant gloves to handle the bearing. Install quickly, tapping into place, if necessary. Install the spacer washer on the shaft. The shaft can be moved toward the front of the case to allow visual inspection of the mating parts.
8. Install both front and rear bearing cups allowing the rear cup to remain projecting from the case between 3/8 and 1/4 inch.
9. Install the rear output carrier gasket and the rear output carrier including seal.
10. Coat the seal surface and splined hole of the rear output flange or yoke (from vehicle) with Lubriplate. Install on the shaft. Lightly coat the washer face of locknut with Permatex; install and tighten.
11. Temporarily install the rear output shaft front cover. Do not install shims. Tighten the mounting bolts to approximately 25 lb. ft. torque. Measure the gap between cover and the case housing. Add .005" to this figure and then select a shim pack that is equal to this calculated figure plus or minus .003". Install shim pack.
12. Check rear output shaft end float between shaft and housing. End float should be between .003" and .008".

## E. Intermediate Shaft Installation

1. Drive the split ring onto the splined section of the shaft from the chamfered end until it seats in its groove. Slip the clutch onto the shaft from the other end — with the external teeth away from the split ring.

Fig. 9

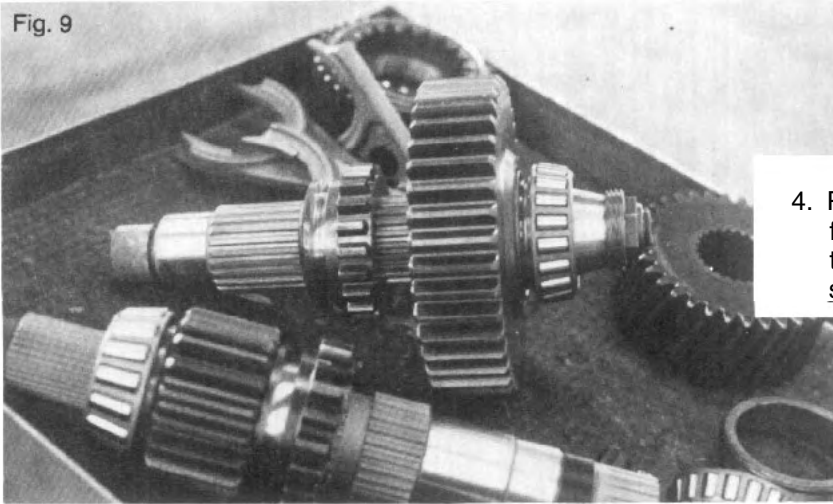

2. While the shaft is outside the case, slip one bearing cone into place. Add the spacer, the under-drive gear (with bearing cups), the second bearing cone, the spacer washer (on mechanically driven speedometer models) and front bearing cone which has been heated to 250 degrees F. Handle the bearing with special heat resistant gloves. On models with mechanically driven speedometer, install the speedometer drive gear spacer, the speedometer drive gear and locknut. On models with electronic speedometer, install washer and locknut.

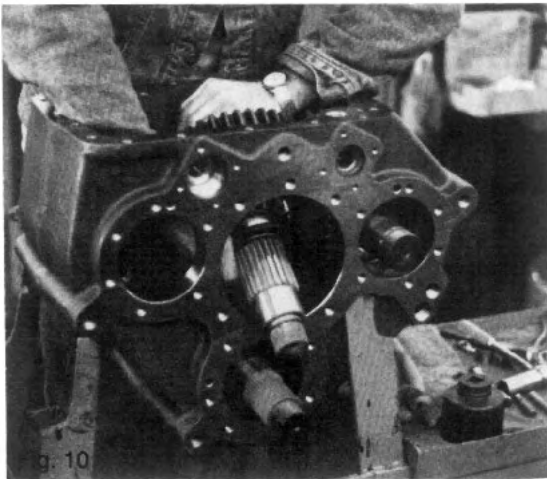

3. Lower this shaft subassembly into the case housing through the case cover opening. Point the rear end of the shaft through the intermediate cap opening. Now move the shaft forward and out the intermediate shaft opening in the front of the case housing.



Fig. 11

4. Pass the 34T direct drive gear (with the chamfered end of the bore toward the split ring) through the rear opening and into place on the shaft.

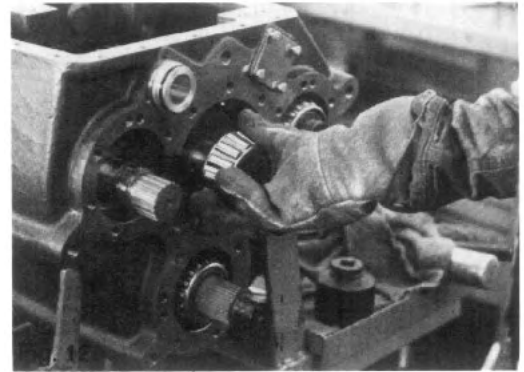

5. Heat the intermediate shaft rear bearing cone to 250 degrees F; handle the heated part with heat proof gloves. Place this part in place on the shaft. Add the washer and the rear locknut.
6. Apply a light coating of Lubriplate to the bearing cone bore in the intermediate shaft rear cup. Press bearing cup into place.
7. Install a pair of guide pins in the case to guide the cap into place. Hang the intermediate shaft rear cap gasket on the guide pins. Position the cap and tap it into place. Replace the guide pins with capscrews.
8. Install the intermediate shaft front bearing cup.
9. Temporarily install the front cap tightening six capscrews to approximately 25 lb. ft. torque. Measure the gap between the cap and the case housing. Add .005" to this dimension. Select a shim pack equal to this total within plus or minus .003". Install the shim pack and front cap.
10. Check the shaft axial float. End float should be between .003" and .008".

## F. Input Shaft Assembly

1. While the input shaft is not in the case:
  - a. Install the split retaining ring.
  - b. Slide the 19T underdrive pinion gear onto the shaft. The counter bore in the gear should fit completely over the split ring.

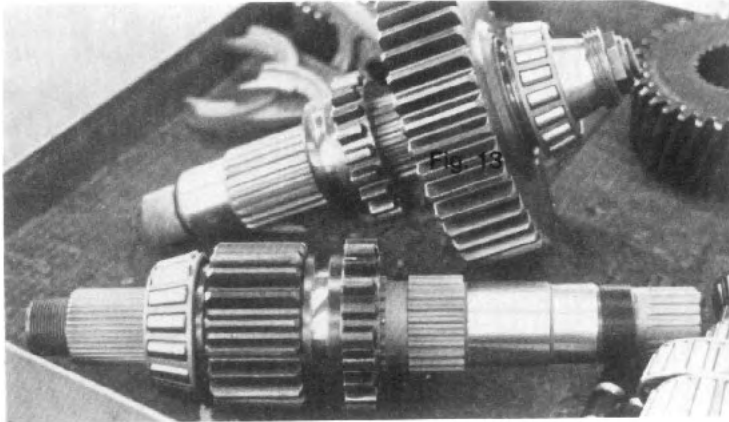

- c. Heat the input bearing cone to 250 degrees F, handle with heat proof gloves and slip onto the shaft tight against the gear.

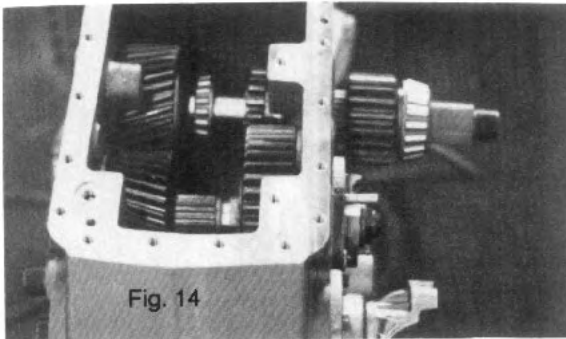

2. Position the direct drive gear, with bearing cups pressed in, inside the case resting on the intermediate shaft's direct drive gear and against the housing wall.

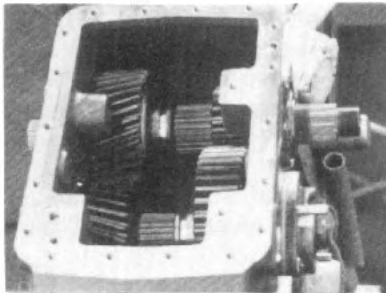

3. While holding the clutch inside the case with the external teeth toward the rear of the case, pass the shaft subassembly through the front opening and into the clutch. Slide a bearing cone into place. Slide spacer onto the shaft. Lift the direct drive gear enough to pass the shaft through.
4. Slip the second direct drive gear bearing cone into the back of the gear. Heat the input shaft rear bearing cone to 250 degrees F and slip into place. Tap lightly to insure proper seating.



5. Put the input shaft rear bearing cup into place in the case bore along with the spacer ring. NOTE: This ring is not used when a PTO is installed. Refer to PTO instructions.

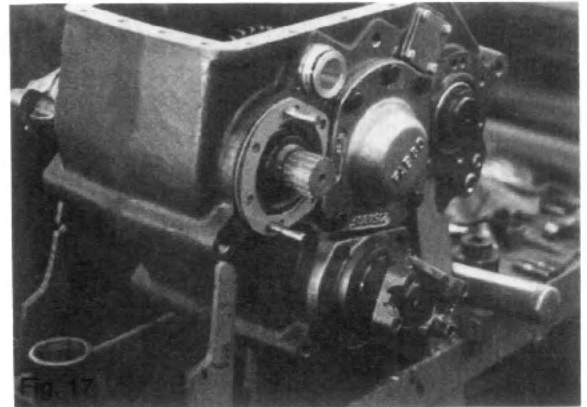

6. Temporarily fasten the rear cap to the housing with two opposing bolts without any shims.
7. Insert the input shaft front bearing cup in place. Position the gasket on the front of the case. Install the input seal carrier with seal to the front of the case. Install the universal joint end yoke.
8. Remove the rear cap and install the rear bearing locknut.
9. Temporarily mount the cap with the capscrews tightened to 25 lb. ft. torque. Measure the gap between the cap and the case housing. Add .005" to the measured dimension. Select a stack of shims that is equal to the total plus or minus .003". Install the shims, cap and capscrews.

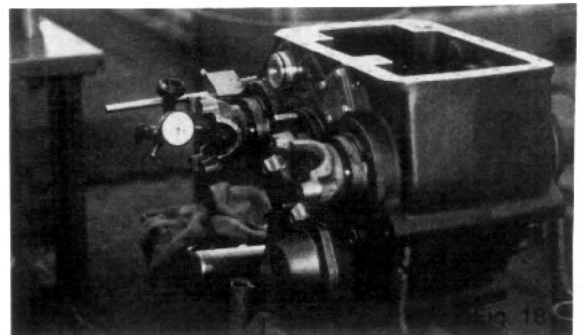

10. Check the shaft end float between the shaft and the housing. End float should be between .003" and .008".



## G. Air Shifter Shaft Installation

1. Install two O-rings into the grooves on each of the cylinder adaptors. Coat with gear lubricant or Lubriplate and install on the case housing.
2. Place the small (piston-to-shift-shaft sealing) O-ring over the threaded end of each shift shaft. The shallow counterbore in the piston should be toward the shoulder on the shift shaft; install a piston, retaining washer and piston retaining nut on each shaft. Tighten the nuts.

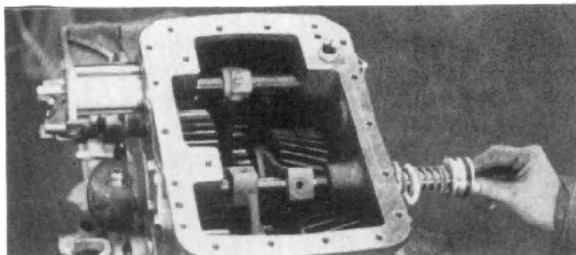

3. Install a spring on each shift shaft against the piston. Place a nylon stop ring over the end of each shift shaft. Insert the shafts into the proper shift adaptor but only part way across the case.
4. Start the set screws into the shift forks.
5. Install the forked end of the 7 5/8" overall length underdrive shift fork into the groove of the underdrive shift clutch (on the intermediate shaft). The long hub section should face the rear of the case. Slide the forward end of shift shaft into underdrive shift fork. Put 5 7/8" overall length shift fork (direct drive shift fork) long hub toward the front of the case, into the case with the forks in the groove in the direct drive clutch on the input shaft. Now push shift shaft through this fork and into the hole in the front wall of the case housing. Push on the end of the piston and compress the spring until the piston butts against the nylon stop ring and the adaptor. This will allow the set screw in the underdrive shift fork to be tightened into the proper groove. Rotate both shift forks in either direction but in the same direction and, with the second fork in the proper place longitudinally, tighten set screws to specified torque and install the lockwire.
6. Place the forks of the front drive shift fork 6 3/4" long overall) in the groove in the front drive clutch. Pass the rear end of the front drive shift shaft through the shift fork and into the hole at the back of the case. Rotate the shaft to position

the longitudinal groove away from the indicator light switch hole. Push on the piston enough to put the groove in the shaft under the set screw in the shift fork. Tighten the set screw to specifications and lockwire.

7. Soak the air shift piston felt strips with gear oil and install in the shallow groove of the piston (shift shaft side of piston). Install the shift piston O-ring in the deeper groove on the pistons. Oil the rings.

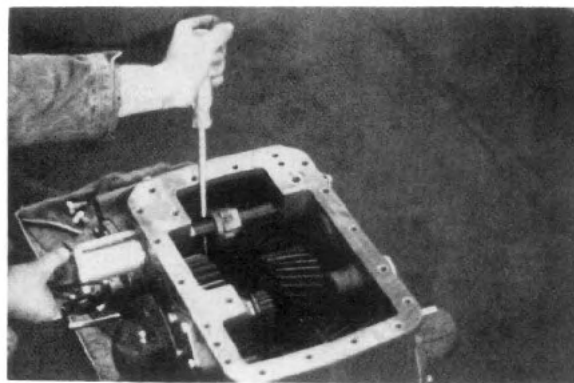

8. The shift cylinder tubes are of differing lengths. The shortest tube (which is 3 1/16" long) should be slipped over the front axle shift piston on the front of the case. The longest shift cylinder tube (which is 3 13/16" long) should be fitted over the high-underdrive shift piston on the rear of the case.
9. Refer to the PTO service manual if the transfer case is equipped with a PTO unit. Neutral is obtained through the use of a "piggyback" cylinder mounted on the high-neutral cylinder when a PTO is installed.
10. Insert O-rings in cylinder caps, install cylinder caps on cylinder tube open ends. Fasten to case housing with the appropriate bolts or studs.
11. Install plunger into the front drive switch hole with the rounded end toward the shaft. Install the shift indicator switch with one copper washer. Test switch operation with a circuit tester while shifting into and out of front drive. Add washers as necessary to make the switch operate properly.
12. Cover exposed end of shifter shafts with the gaskets and covers provided.

## H. Final Assembly



1. Rotate all shafts with shift shafts shifted to all positions. Observe through cover opening. Make sure there are no loose tools, bolts or other foreign objects in the assembly.
2. Install cover gasket and cover, coat bolt threads with Permatex, use a lockwasher on each bolt and tighten to the specified torque.
3. Install drain and fill plugs.
4. Refer to PTO service manual if case is equipped with a PTO unit.
5. Attach all mounting brackets before reinstalling case in the truck.



## IV. TORQUE SPECIFICATIONS

Location/Description	Size	Ft. Lbs. Torque
<b>A. FRONT OUTPUT SHAFT</b>		
Front Seal Carrier Bolts .....	7/16-14	45
Rear Cap Bolts .....	7/16-14	45
Front Output Yoke Locknut .....	1 1/2-12	300
Rear Bearing Locknut .....	1 31/32-18	150
<b>B. Rear Output Shaft</b>		
Front Cap Bolts .....	7/16-14	45
Rear Carrier Bolts .....	7/16-14	45
Models w/Mechanical Speedo		
Front Bearing Retaining Nut .....	1-20	175
Models w/Electronic Speedo		
Front Bearing Retaining Nut .....	1.767-18	150
Rear Yoke or flange Locknut .....	1 1/2-12	300
<b>C. INTERMEDIATE SHAFT</b>		
Front or Mechanical Speedo Cap .....	7/16-14	45
Rear Cap Bolts .....	7/16-14	45
Models w/Mechanical Speedo		
Front Bearing/Mechanical Speedo Nut .....	1-20	175
Models w/Electronic Speedo		
Front Bearing Locknut .....	1 31/32-18	150
Rear Bearing Locknut .....	1 1/2-12	300
<b>D. INPUT SHAFT</b>		
Front Seal Carrier Bolts .....	7/16-14	45
Rear Cap Bolts .....	7/16-14	45
PTO Mounting Bolts .....	7/16-14	45
Rear Bearing Locknut .....	1 31/32-18	150
Input Yoke Retaining Locknut .....	1 1/2-12	300
<b>E. SHIFT SHAFTS</b>		
Seal Carrier & Cap Mounting Bolts .....	7/16-14	45
Air Cylinder Bolts, Studs or Nuts .....	1/4-20	15
Air Shift Piston Retainer Nut .....	3/8-24	30
Shift Fork Set Screws .....	3/8-16	25
<b>F. COVER</b>		
Cover Mounting Bolt .....	7/16-14	45

REV 5/89

# FABCO MODEL TC-38

—FABCO AUTOMOTIVE CORPORATION—

## TRANSFER CASE ASSEMBLY

SERVICE AND PARTS MANUAL

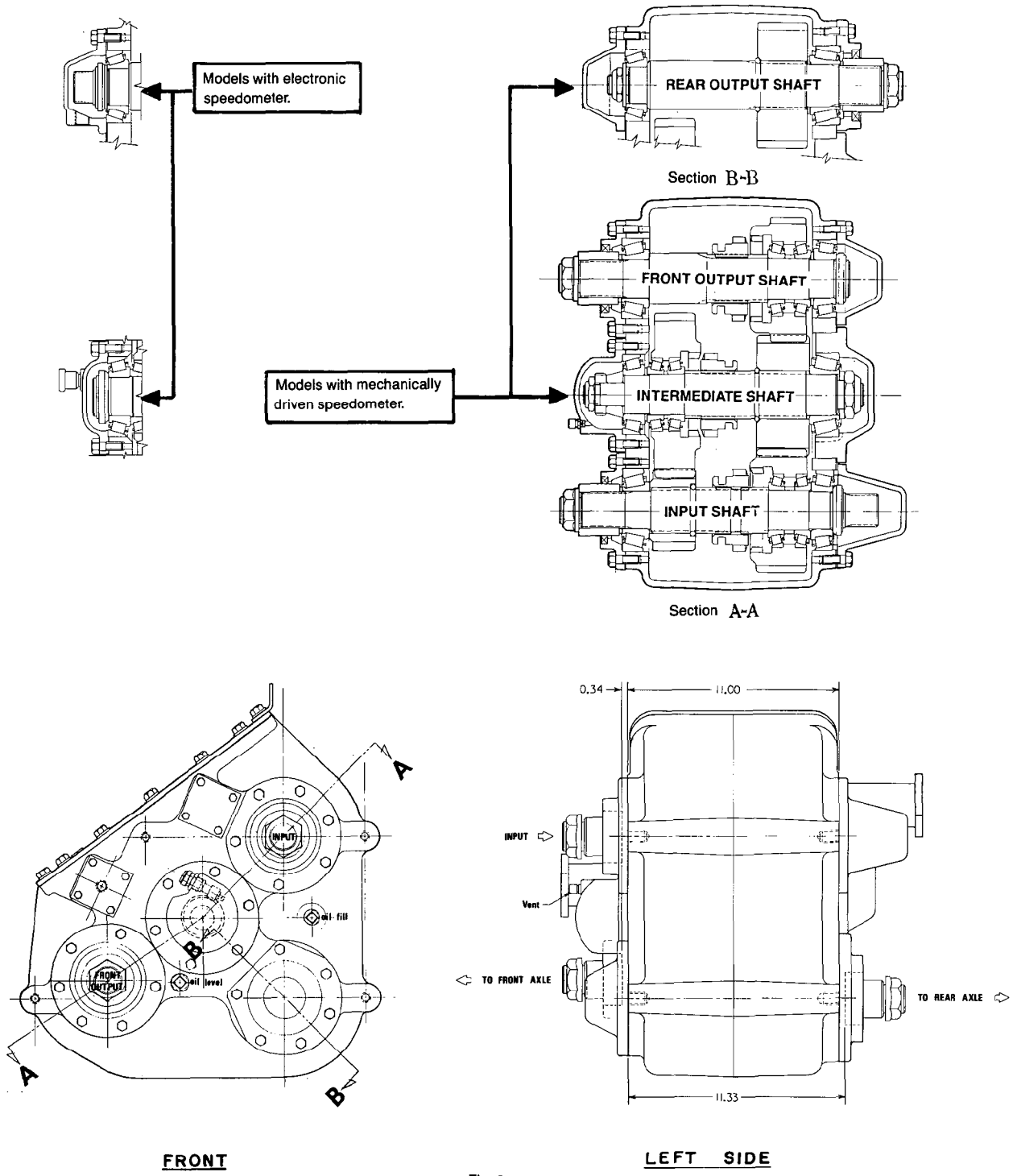

Fig. 21

# I. OPERATING INSTRUCTIONS

## FABCO TC-38 TRANSFER CASE

### A. Front Drive

When travelling through sand, loose dirt, mud, snow, ice, or when ascending grades where the rear wheels might spin, shift to front wheel drive for better traction. Shift before the truck is in trouble. Engagement and disengagement of the front drive axle can best be made while the engine is pulling lightly. It can be shifted at any speed provided the rear wheels are not spinning. The transfer case is equipped with a switch so that the shift is indicated by a pilot light. The light will come on when front drive is engaged.

### B. Underdrive

When slow, positive pulling power is desired, shift to underdrive. Underdrive may be used to obtain a convenient combination with third or direct for climbing some grades. The transfer case should be shifted between high and low range only when the truck is stopped.

### C. Power Take-Off

When the transfer case is equipped with a power take-off, the PTO can be operated without moving the vehicle. To engage, shift the automatic transmission into neutral and shift the PTO while the engine is idling. After the PTO has been engaged, shift the transmission to the desired gear. With a manual transmission equipped vehicle, depress the clutch pedal and shift into the desired transmission gear, shift the PTO and release the clutch.

To disengage the PTO, shift the transmission into neutral (manual and automatic), allow the machinery to come to rest, then disengage the PTO.